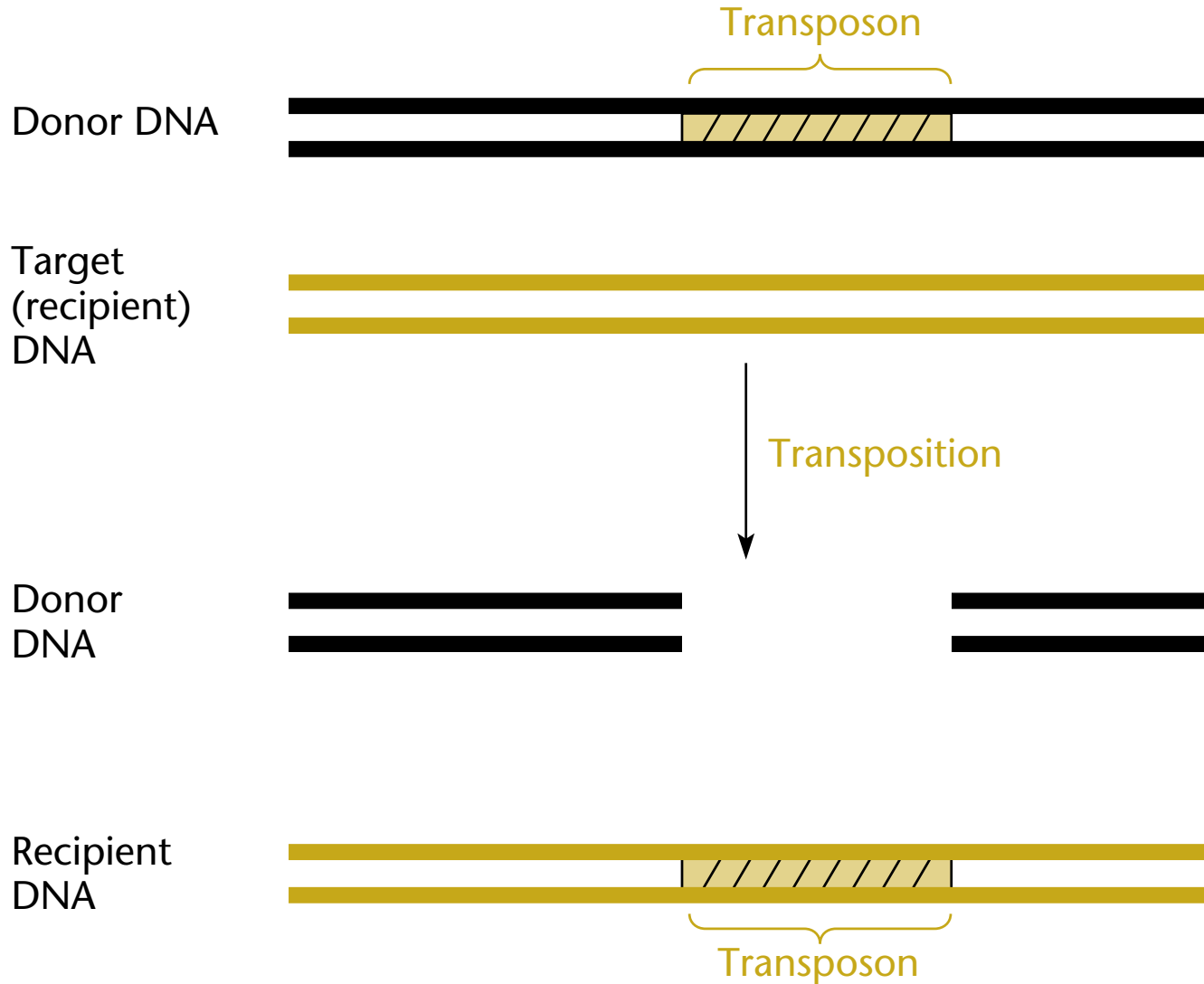
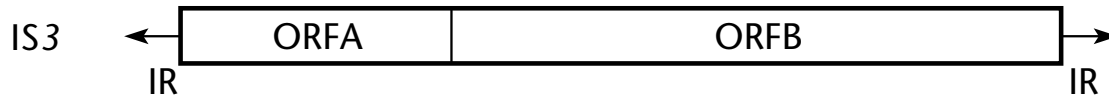

**Figure 9.1**



**Figure 9.2**



Transposition



IR 40-bp inverted repeat

ORFAB Transposase

ATT  
TAA 3-bp target site

Figure 9.3

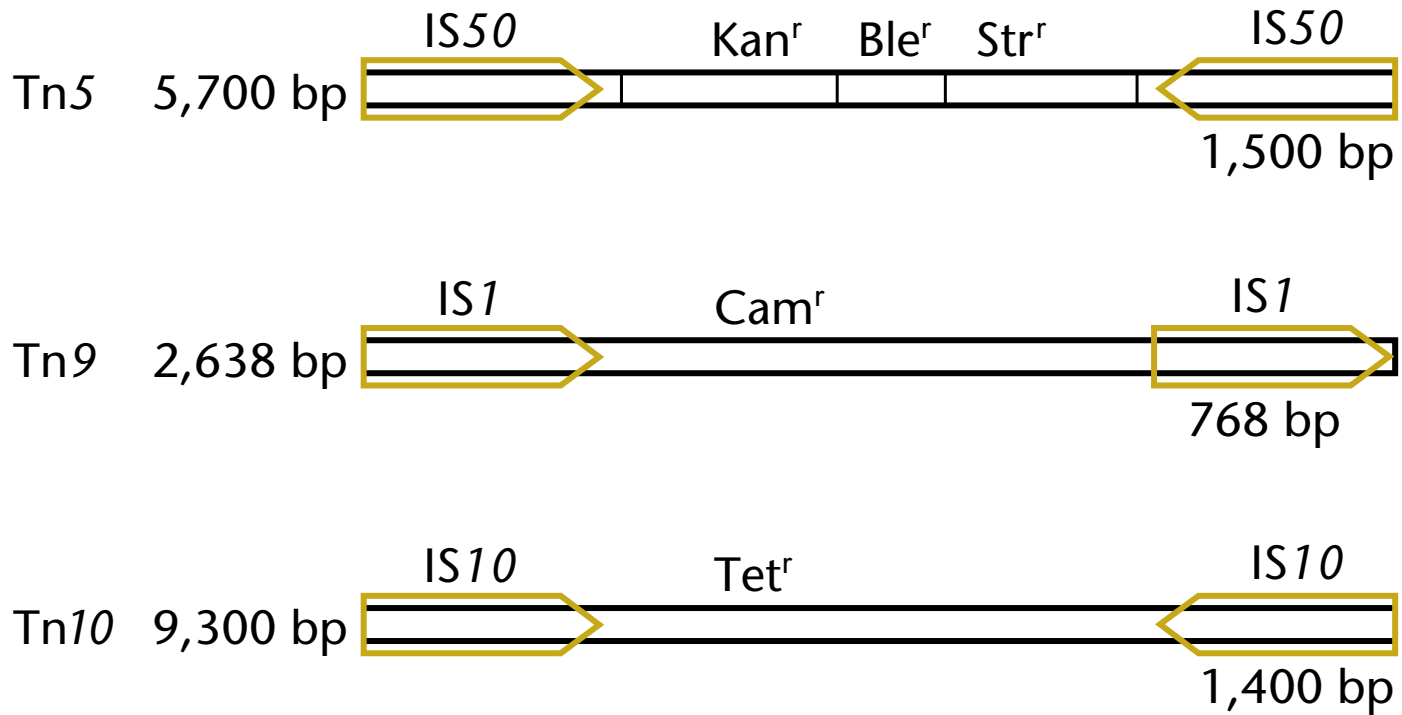

Figure 9.4

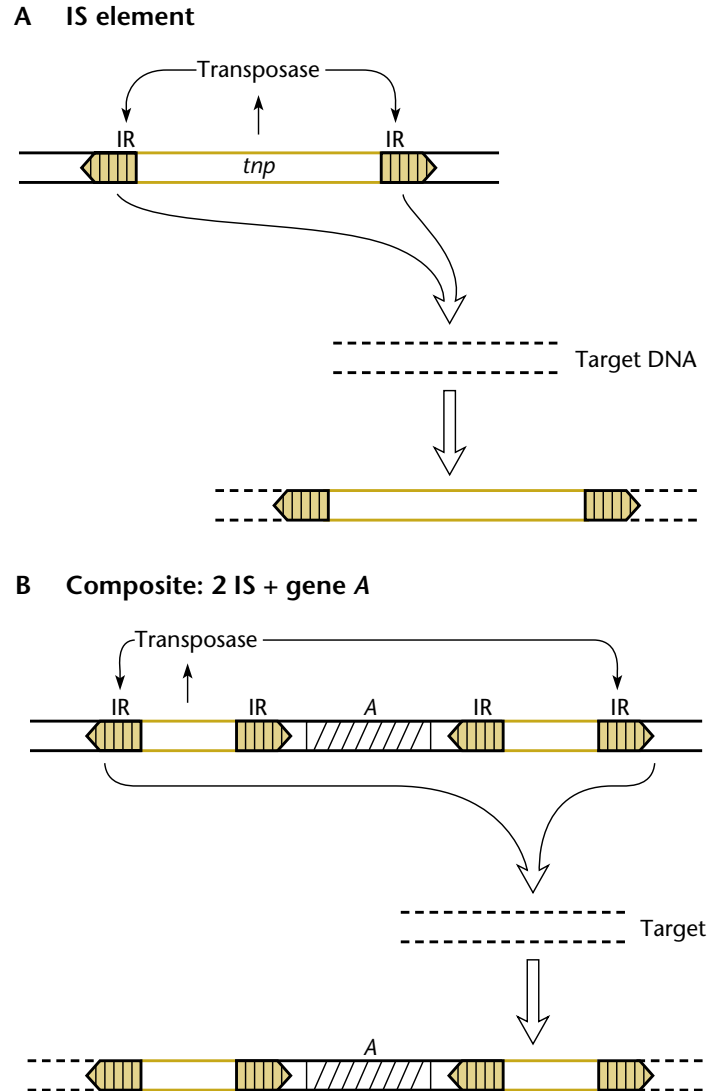
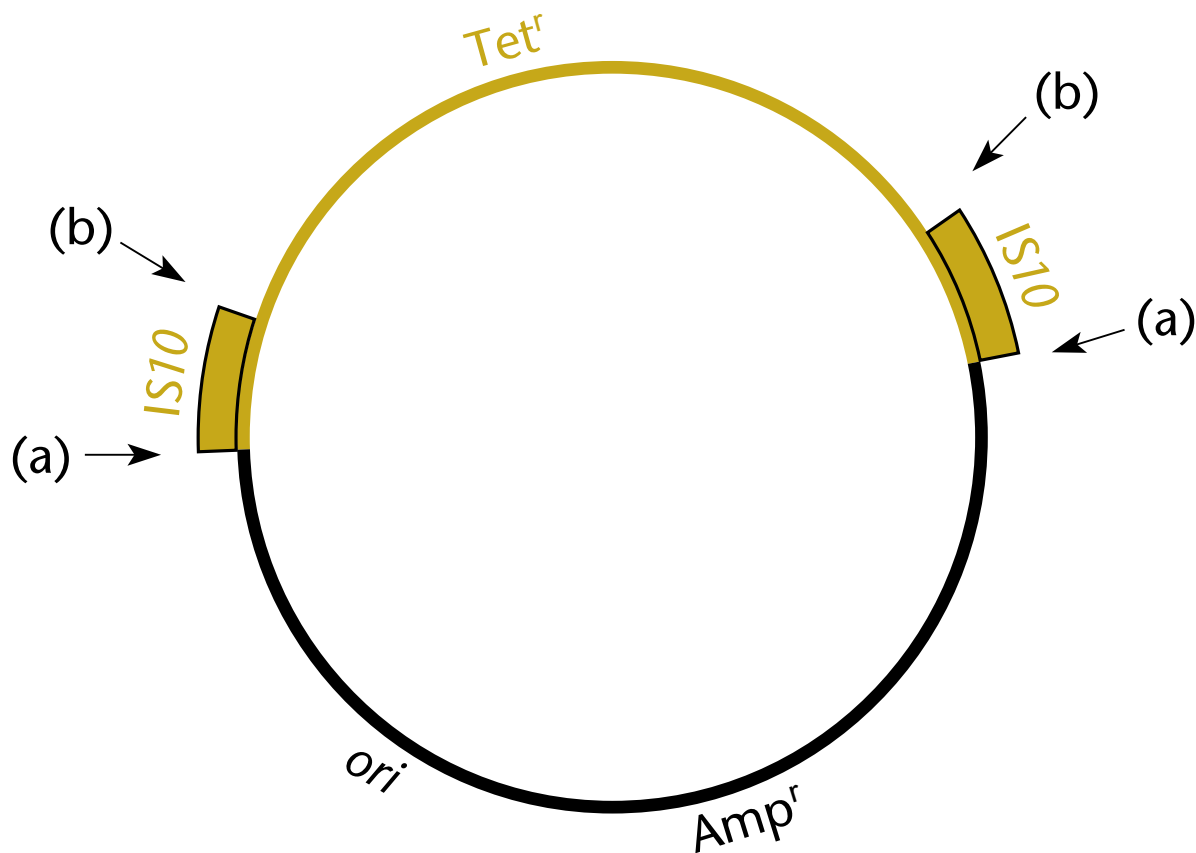
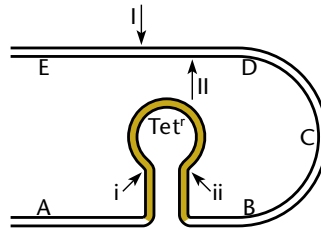

Figure 9.5



**Figure 9.6**



- ① Double-strand breaks at inside ends (i and ii) of transposon Tn10
- ② Staggered break (I and II) in target DNA

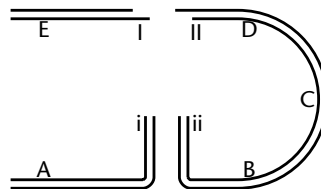

- ③ Tet<sup>r</sup> gene is destroyed

Deletion

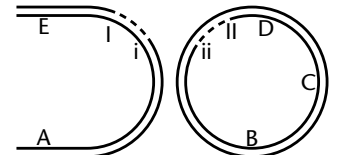

- ④ Ends I and i and ends II and ii are joined

OR

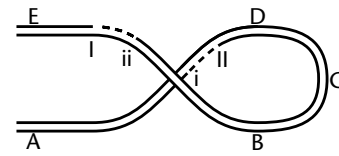

- ⑤ Ends I and ii and ends II and i are joined

Inversion



**Figure 9.7**

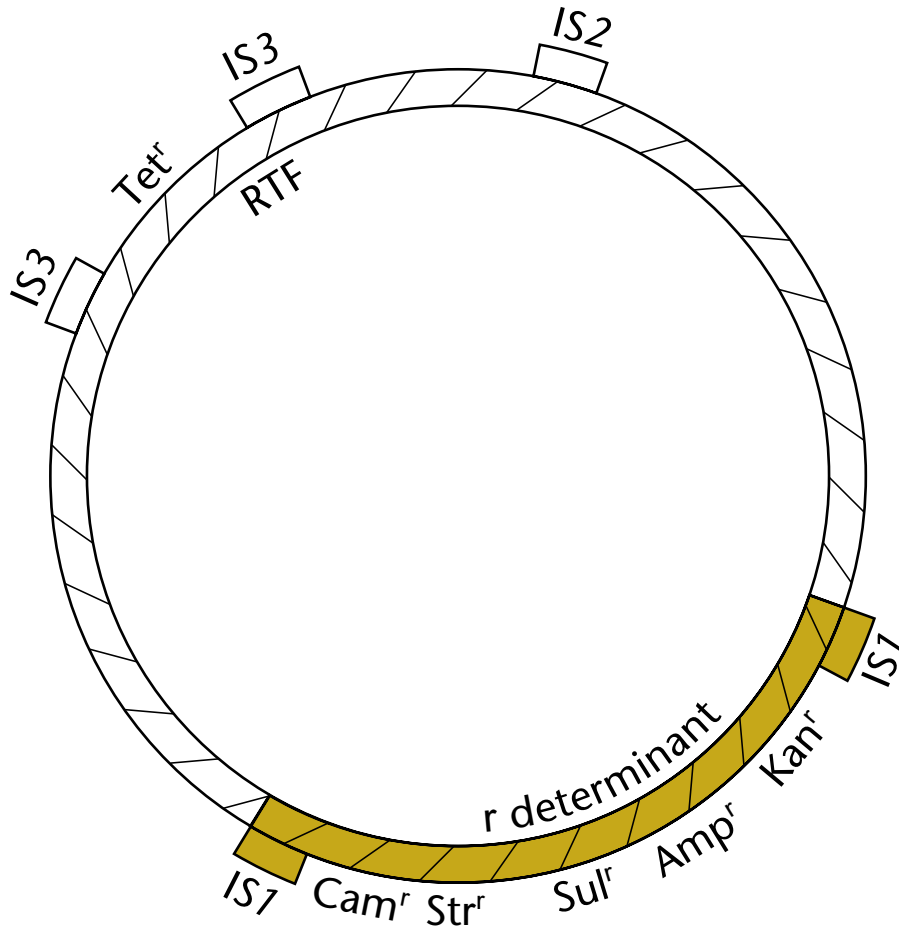

## Figure 9.8

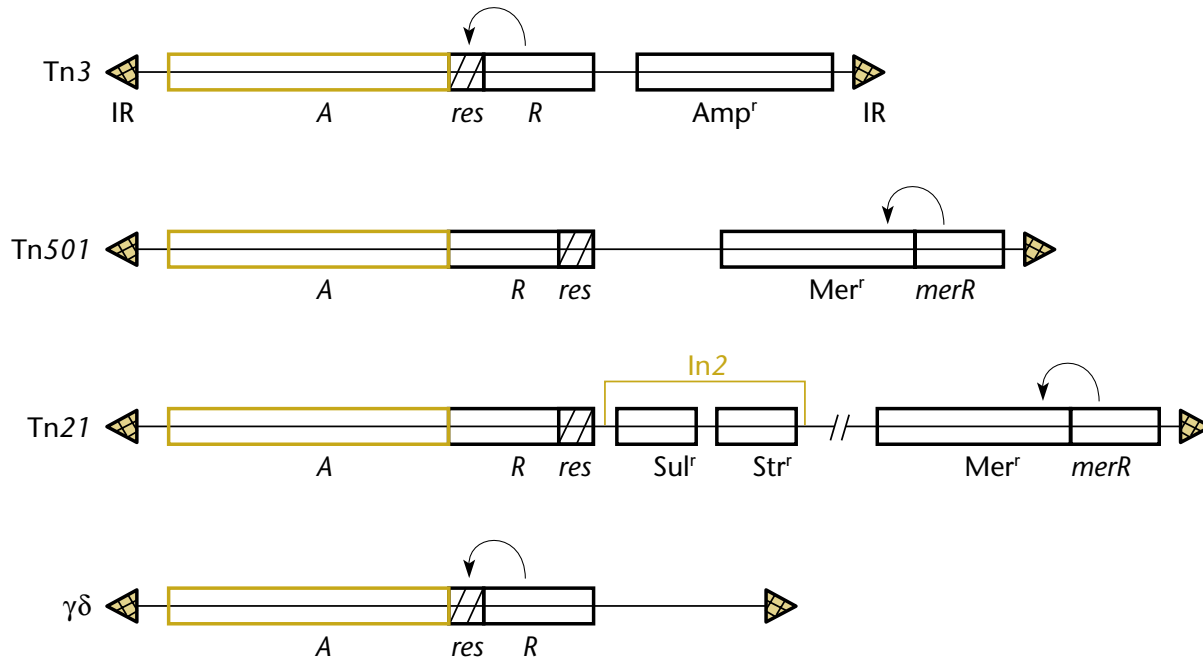



-   Terminal inverted repeats
- A Transposase
- R Resolvase and repressor of A and R transcription
- res* Recombination site
- merR* Regulator of  $Mer^r$  and transposase
- $Mer^r$  Mercury resistance
- $Amp^r$  Ampicillin resistance
- IR Inverted repeat

Figure 9.9

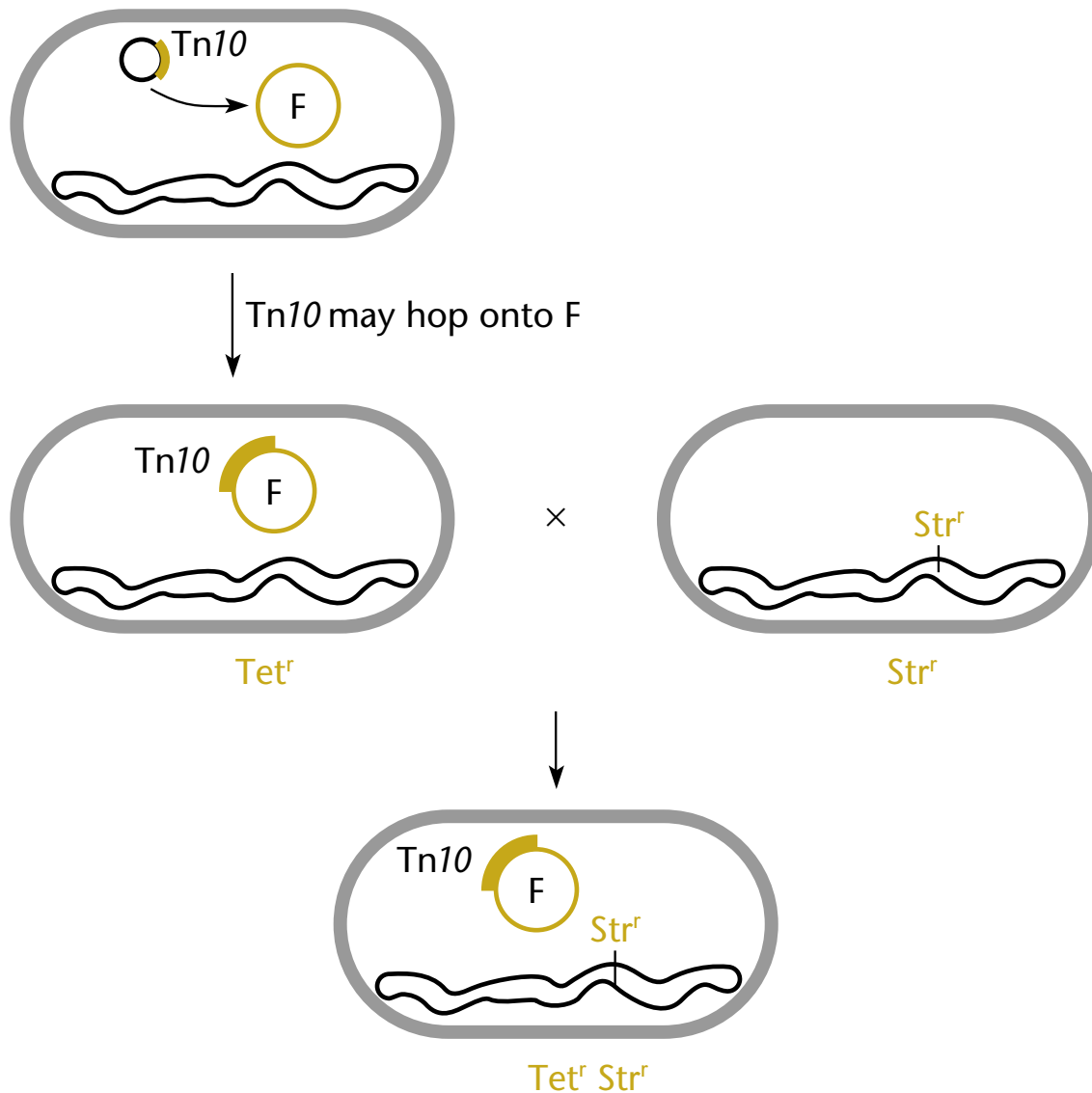

Figure 9.10

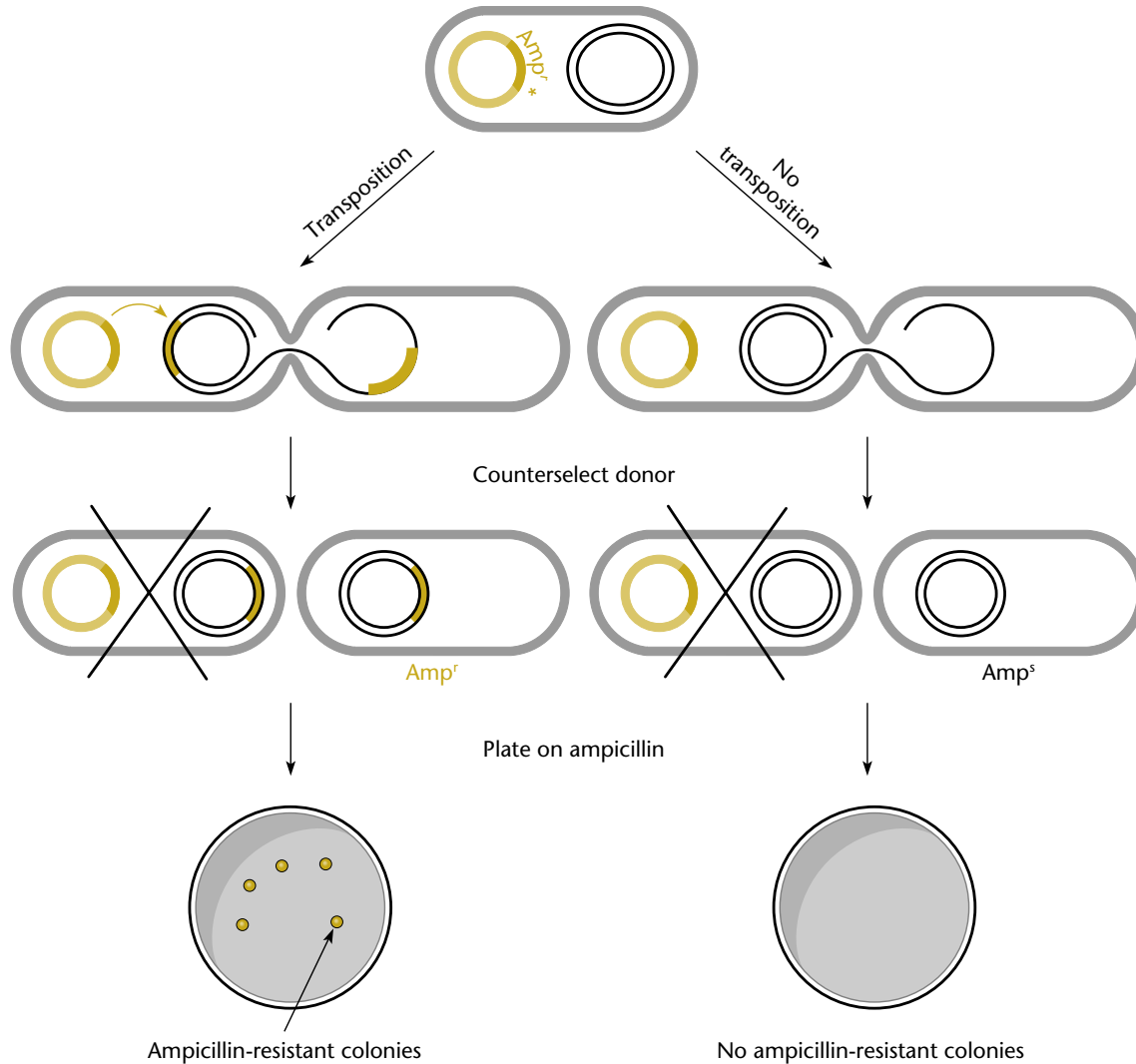

Figure 9.11

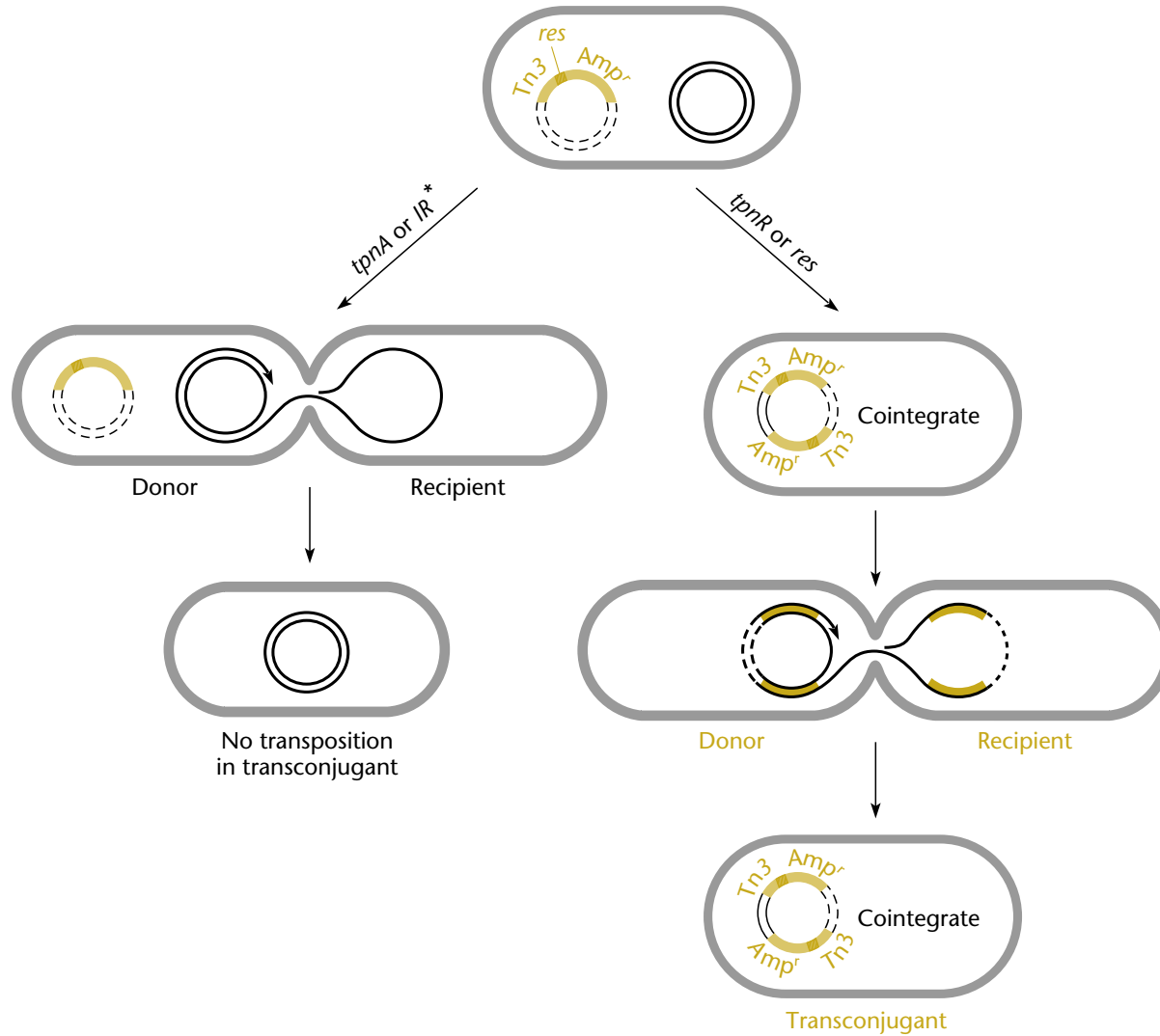
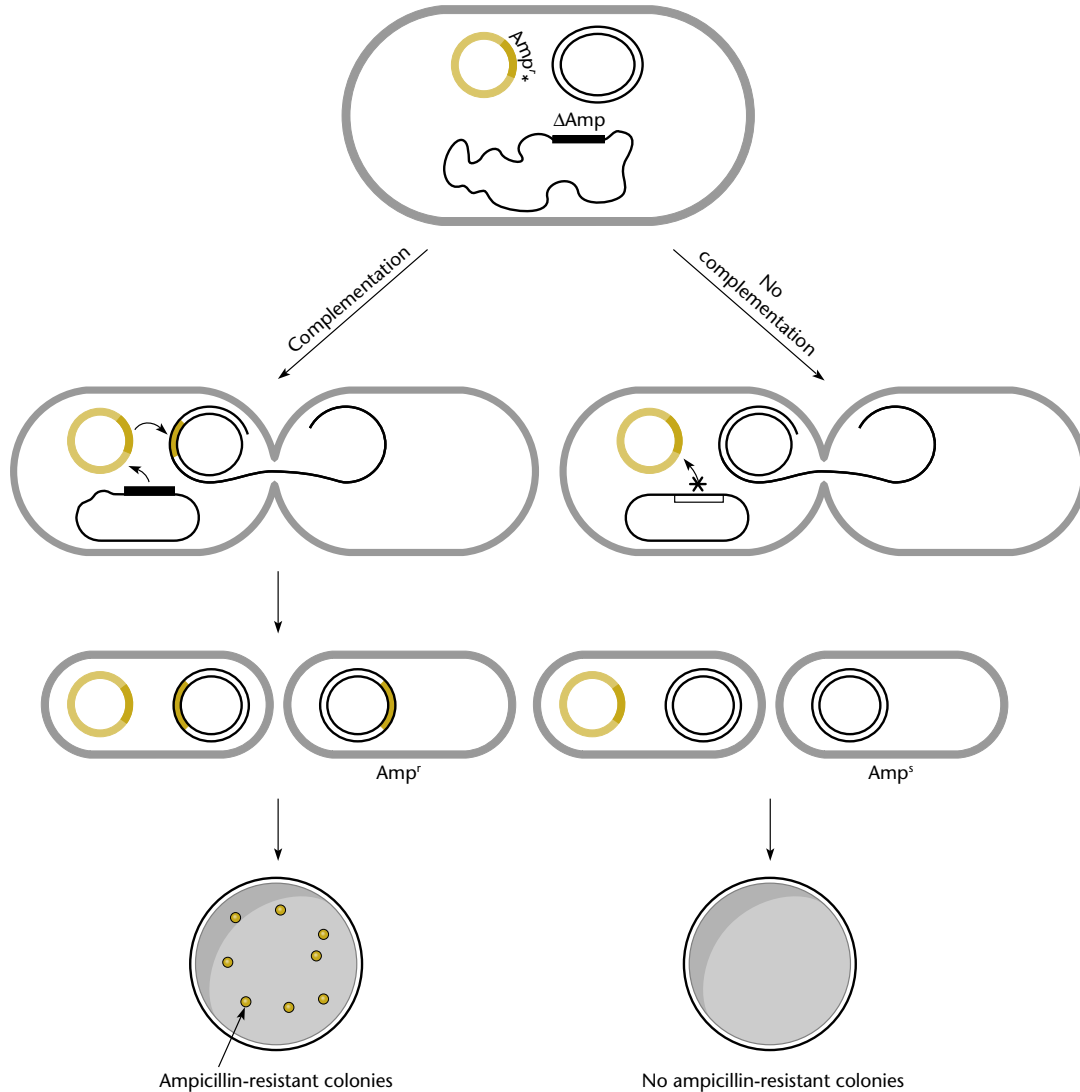
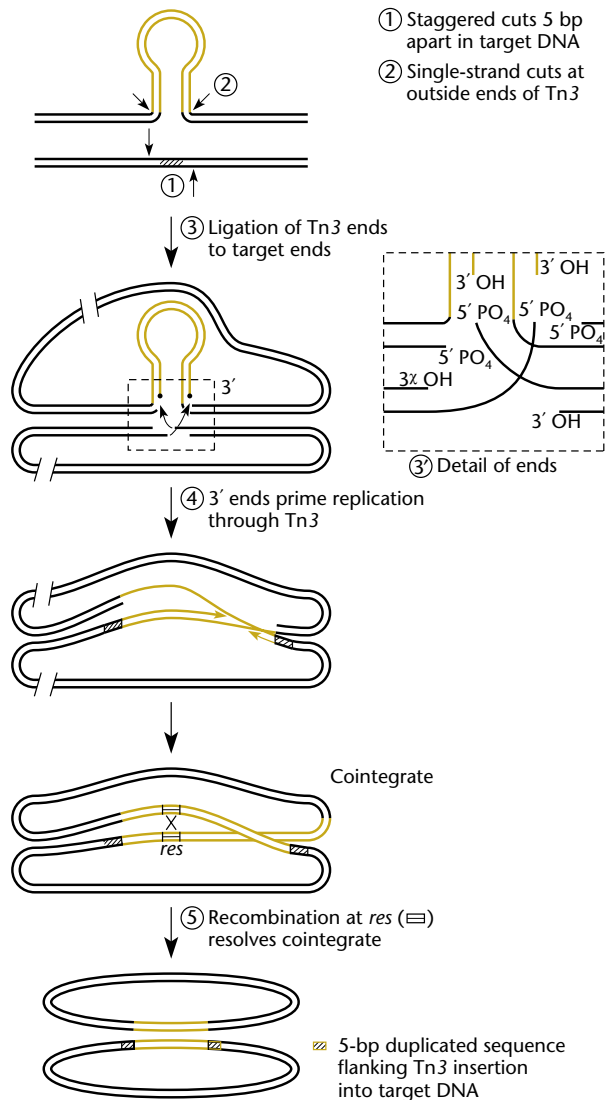

Figure 9.12



**Figure 9.13**



**Figure 9.14**

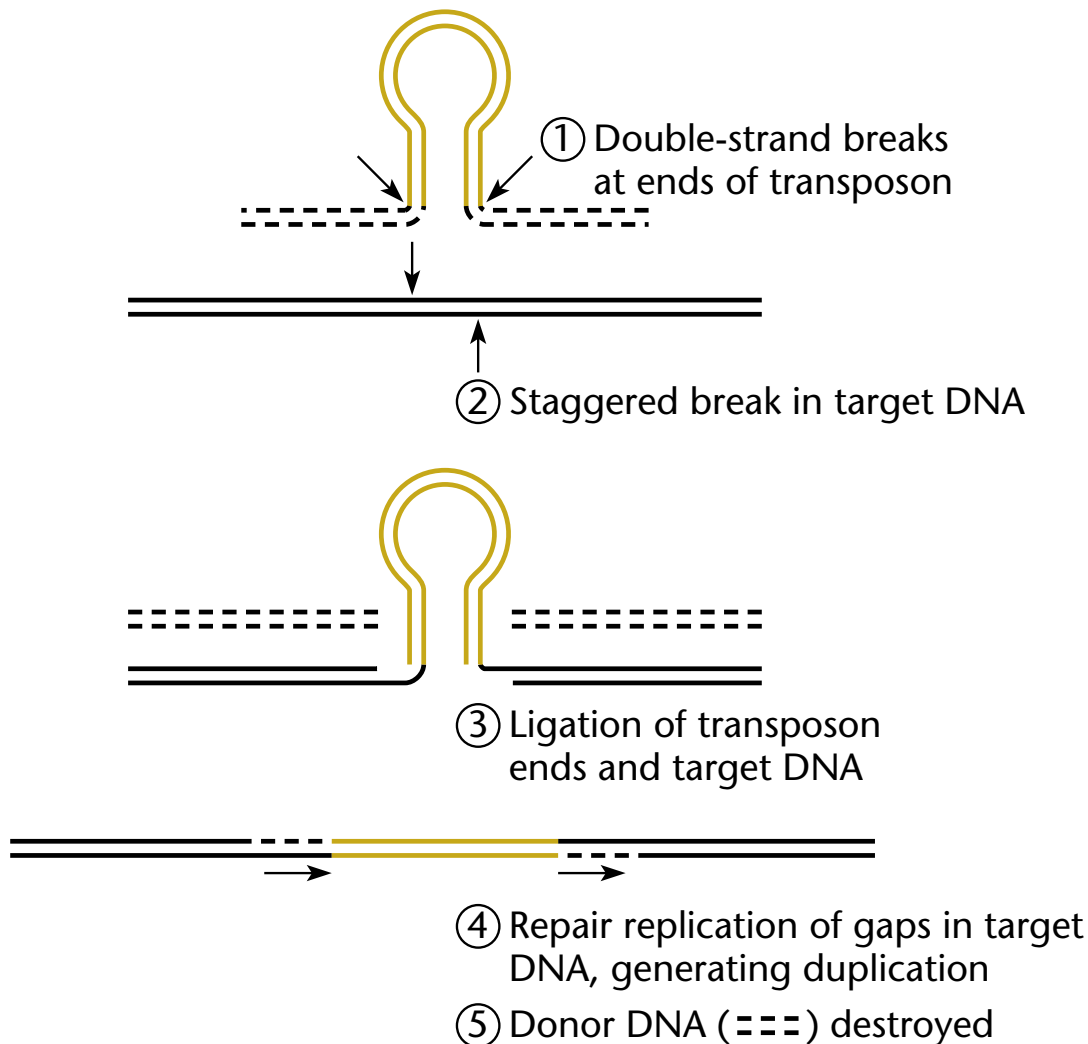

**Figure 9.15**

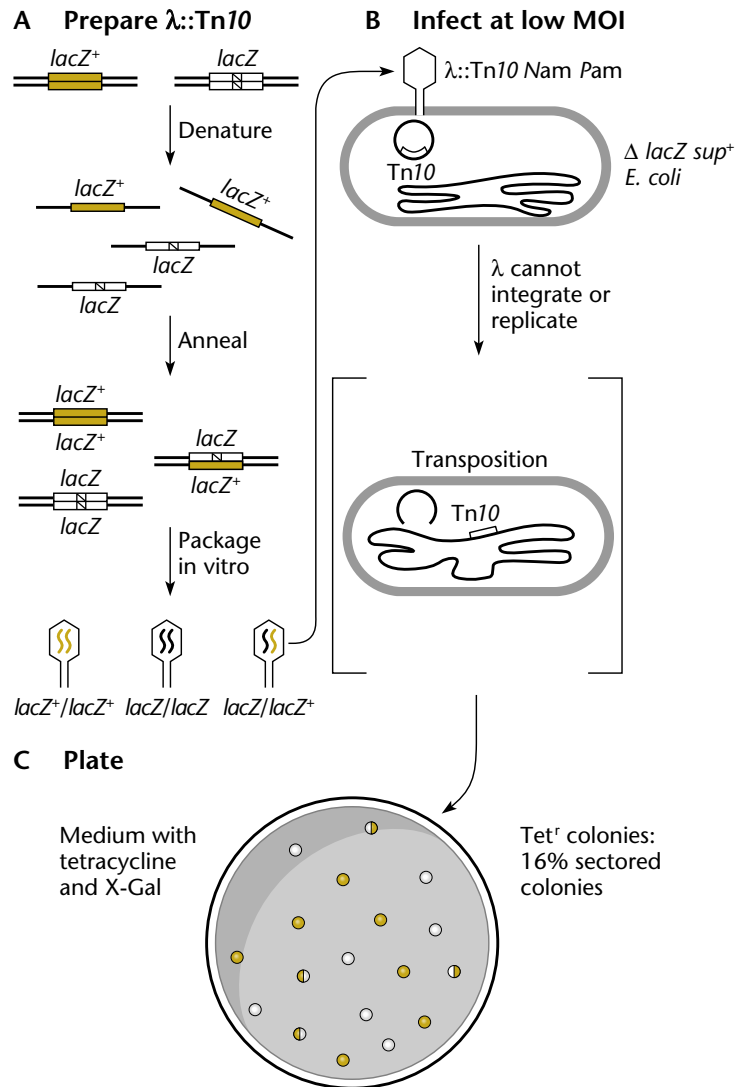

**Figure 9.16**

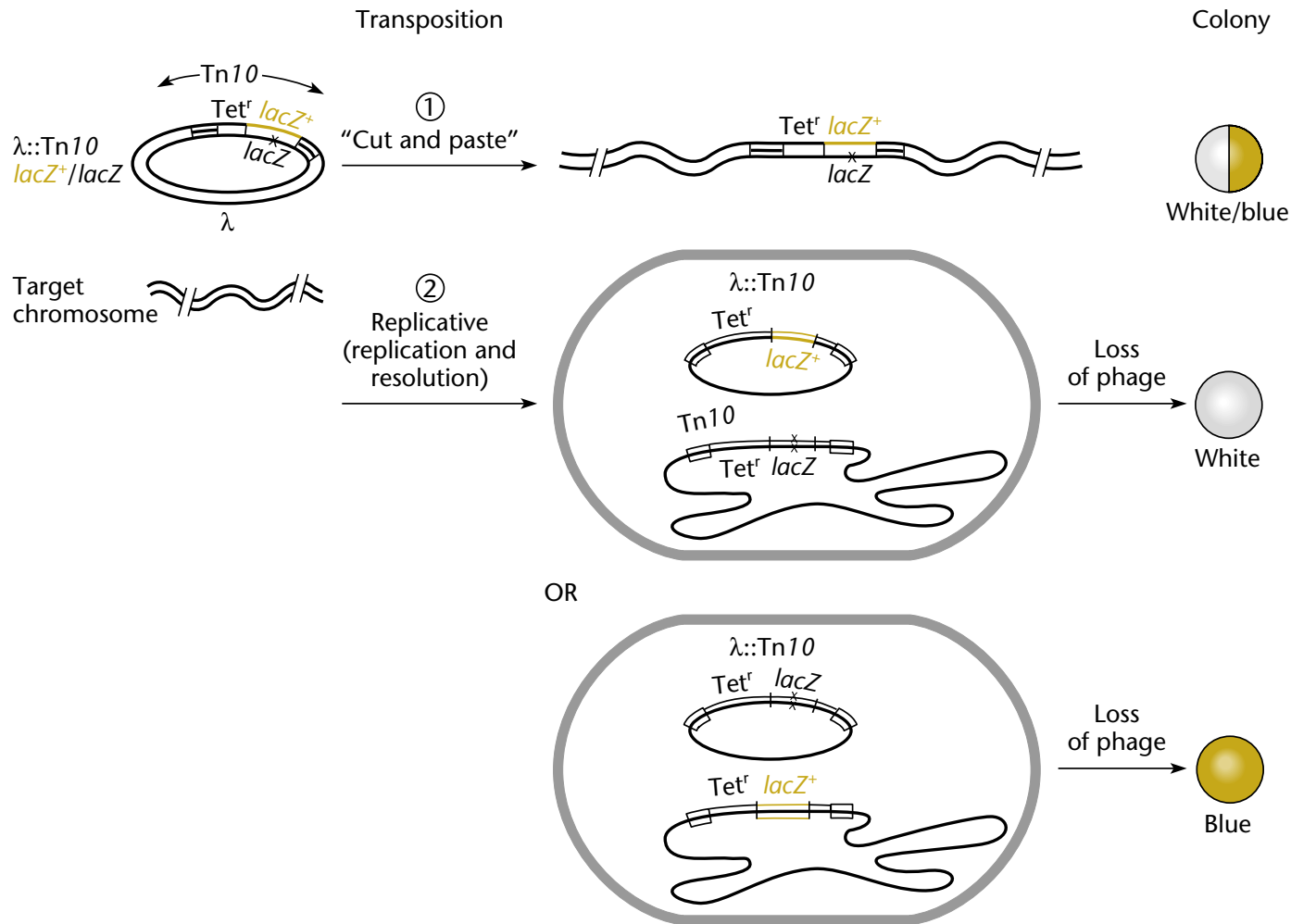

**Figure 9.17**

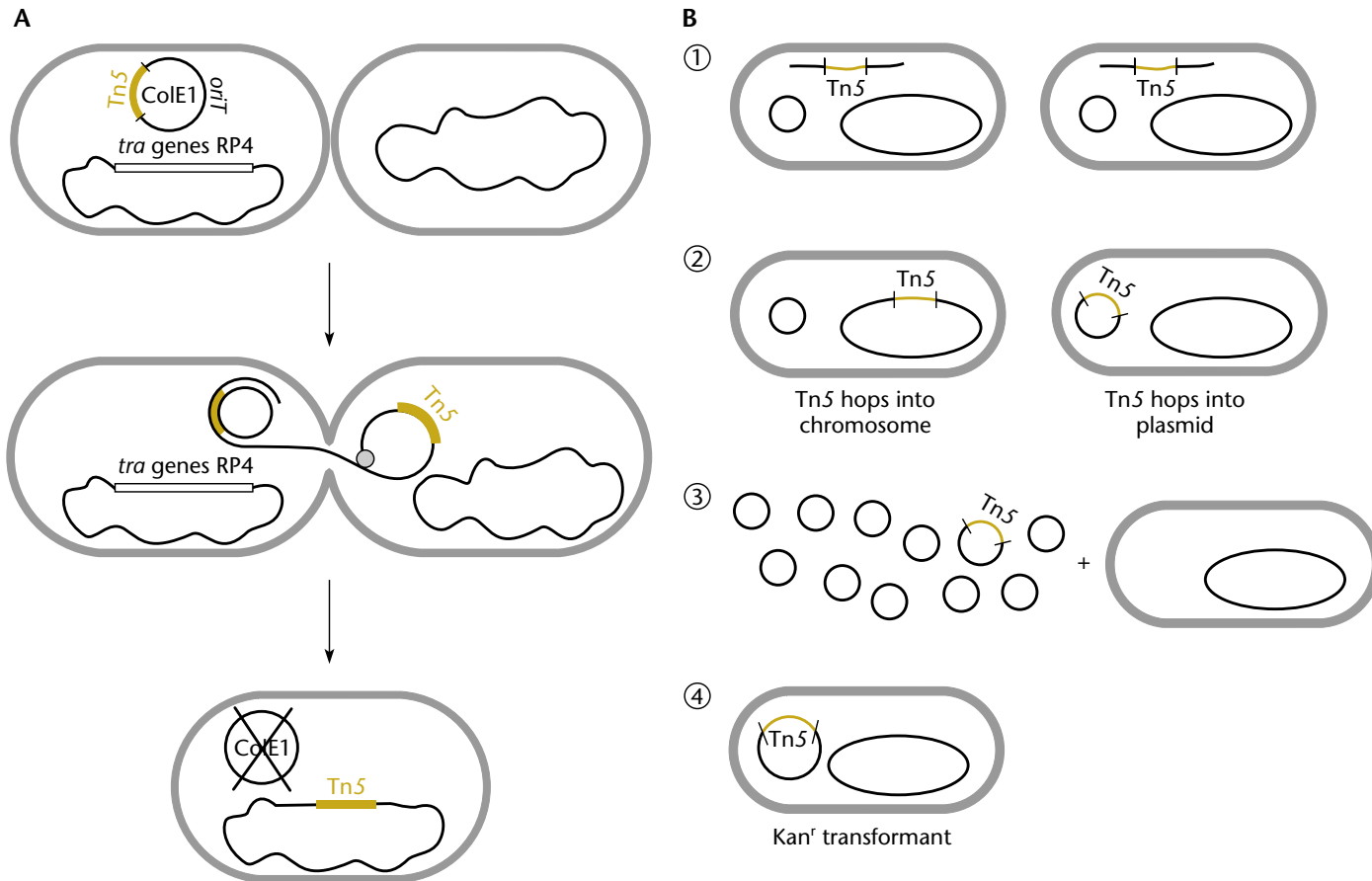

**Figure 9.18**

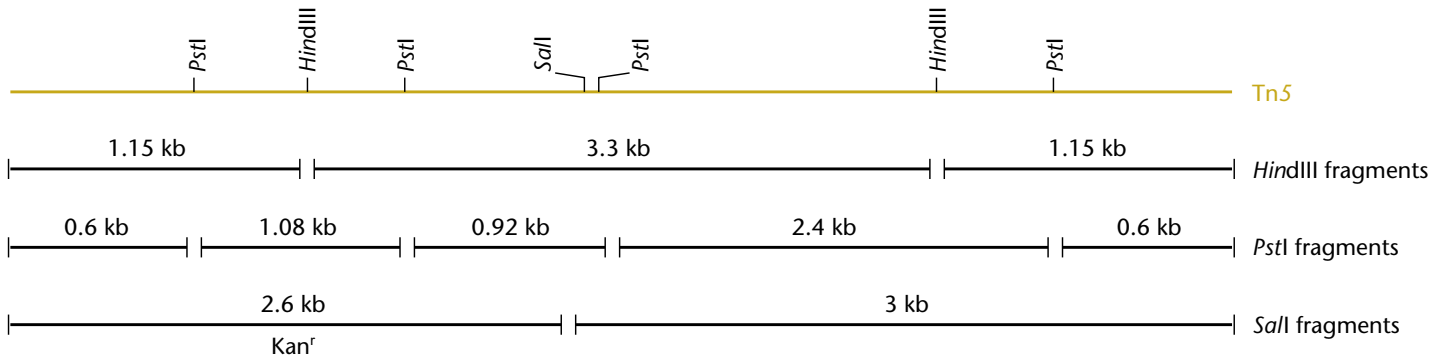
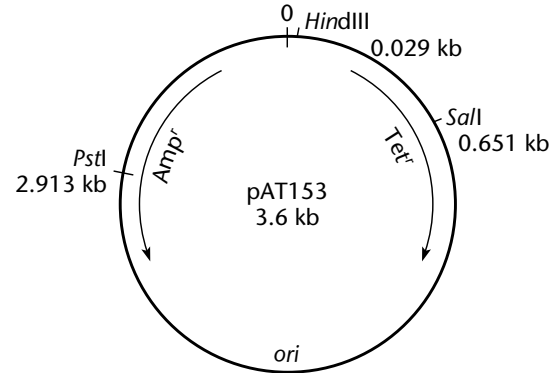

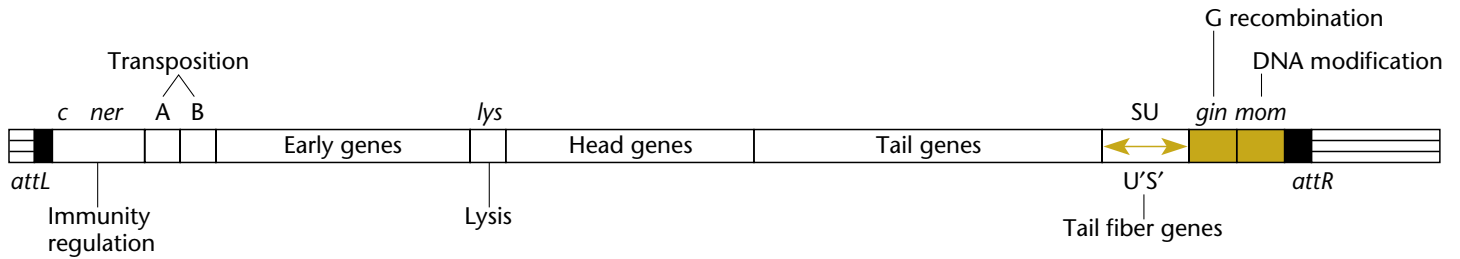

## Box 9.1



 Host DNA in virion

 Attachment sites

 Invertible region (G segment)

 Genes expressed in lysogen

**Figure 9.19**

**A**

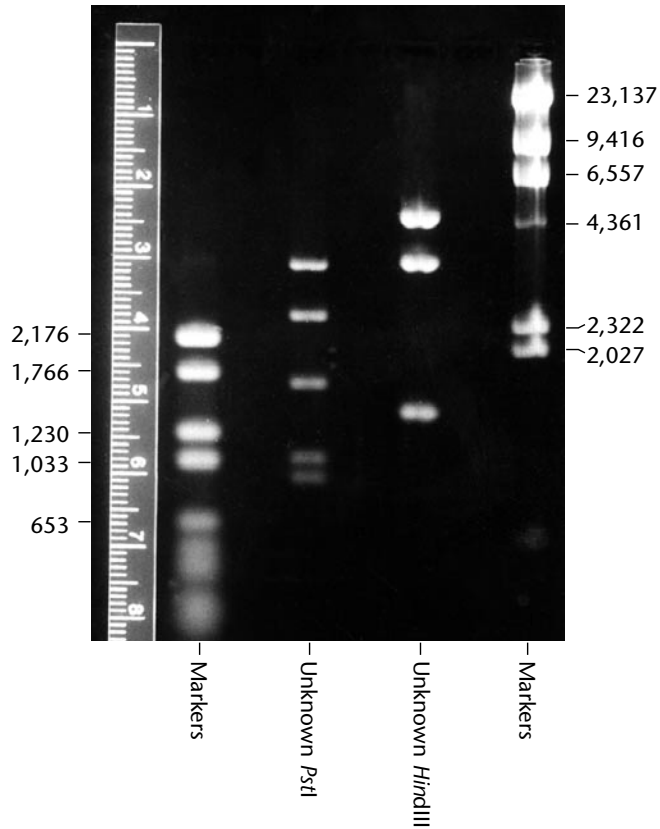

**B**

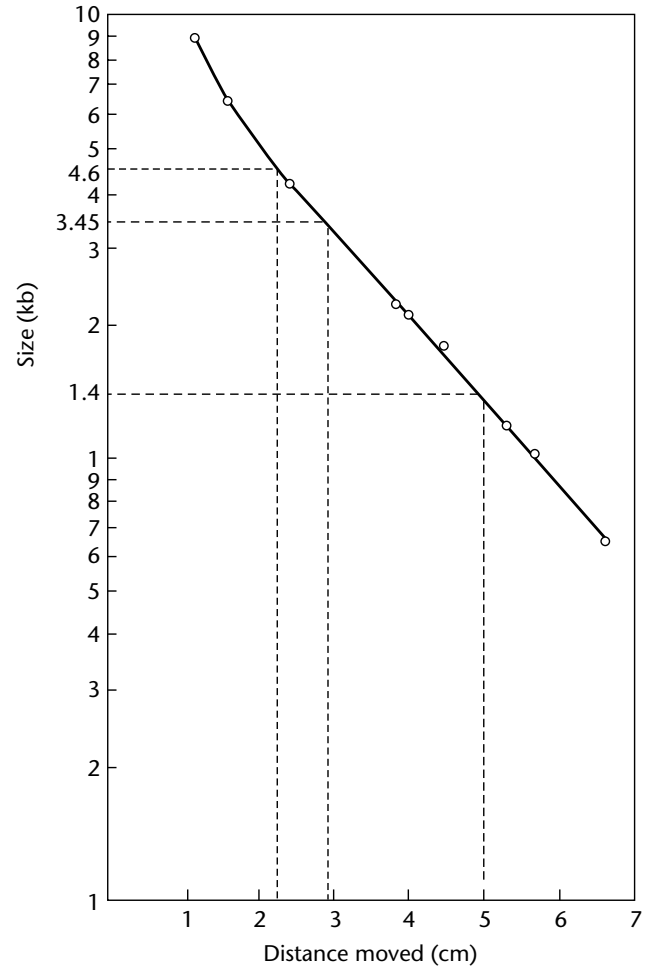

**Figure 9.20**

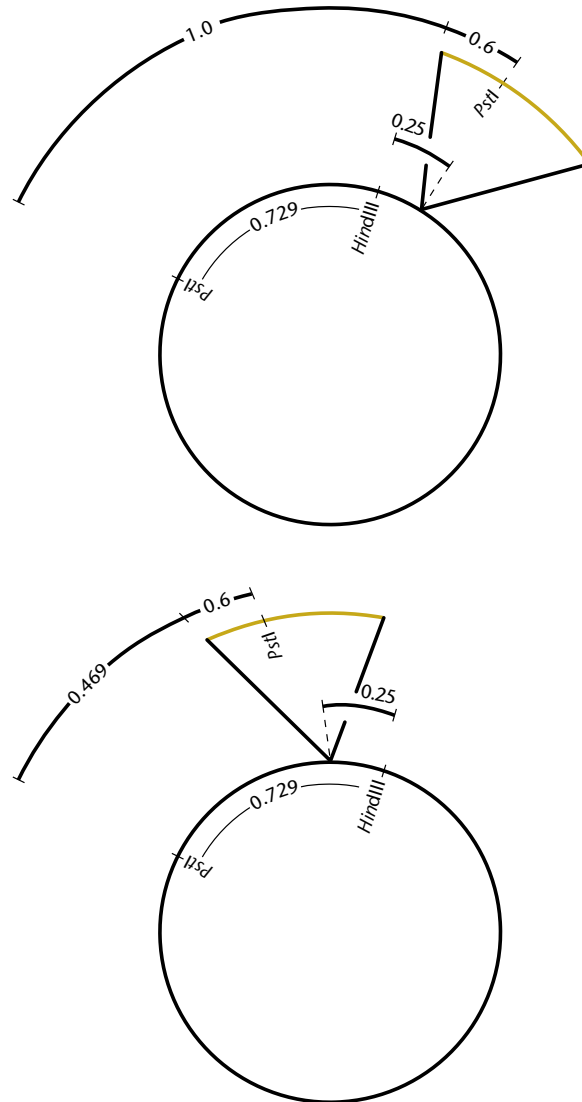

## Box 9.2

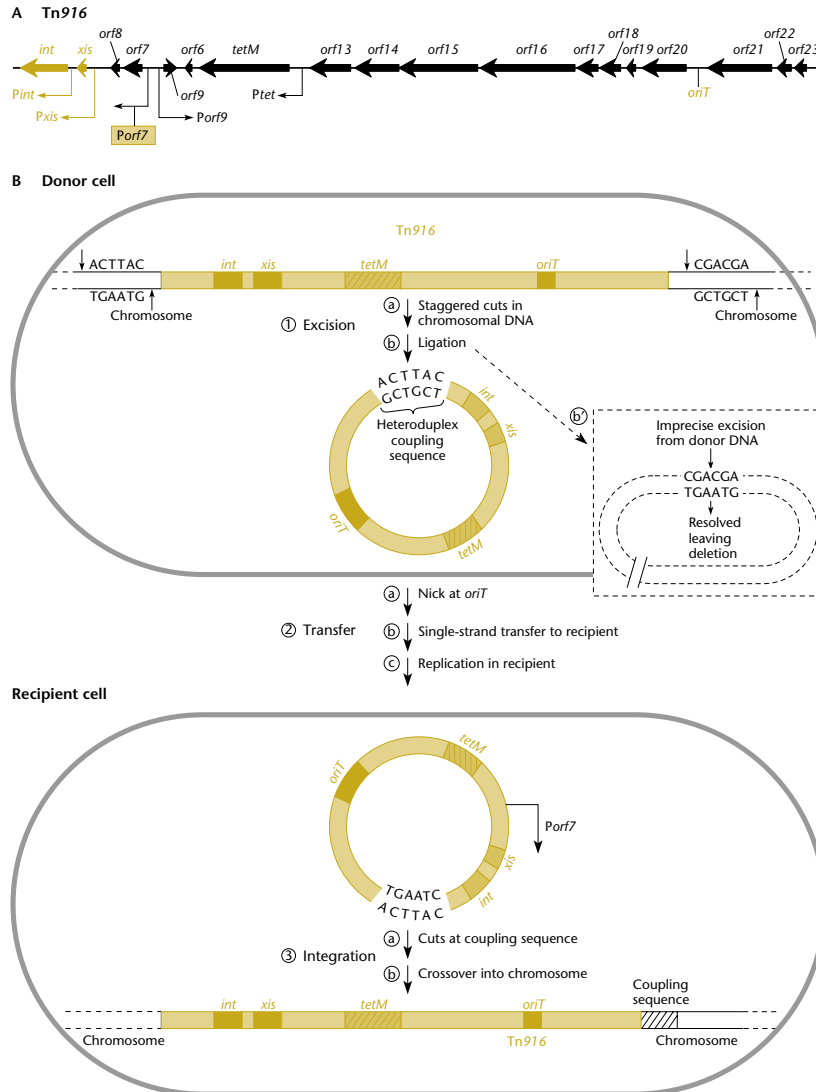

Figure 9.21

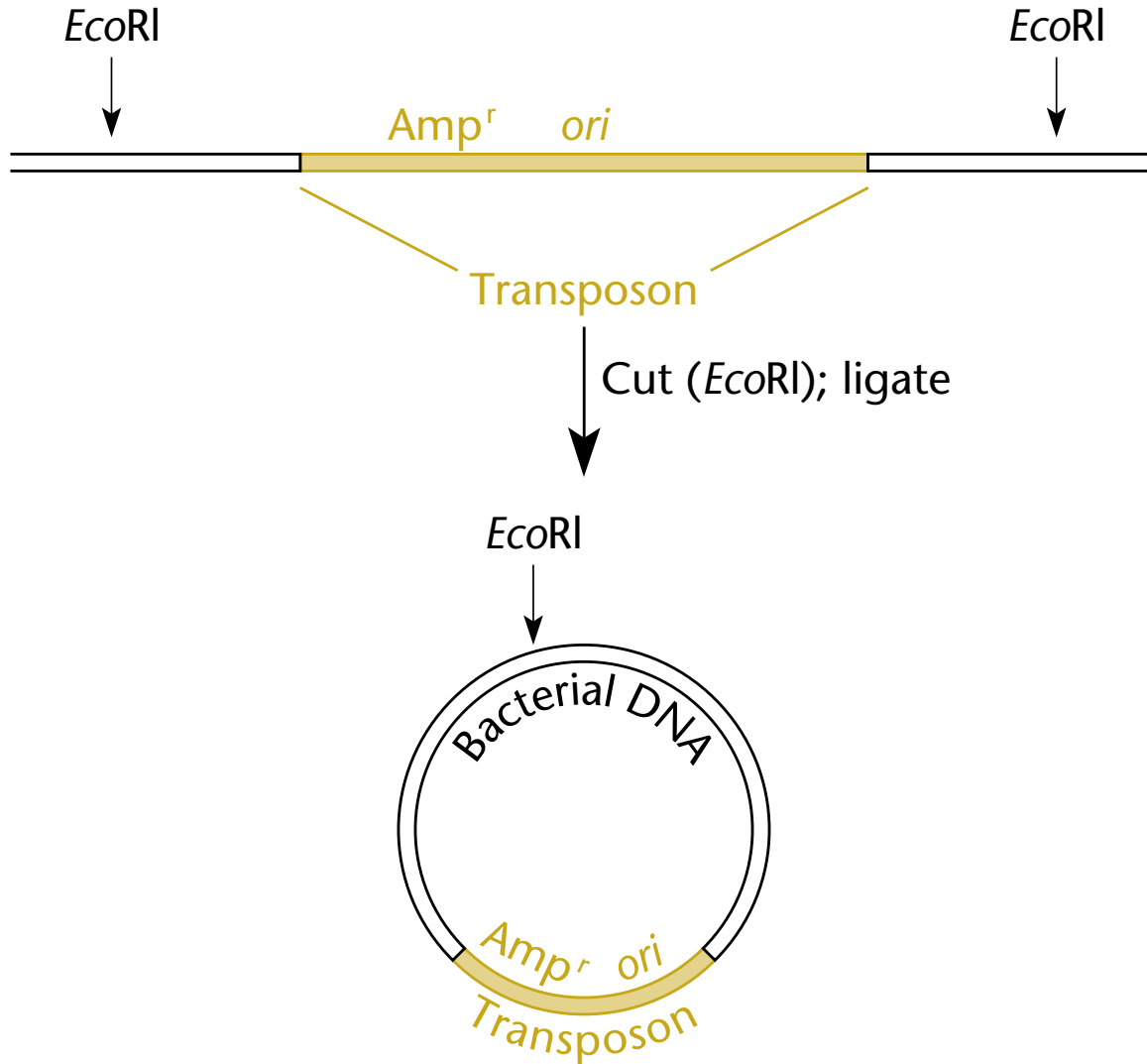
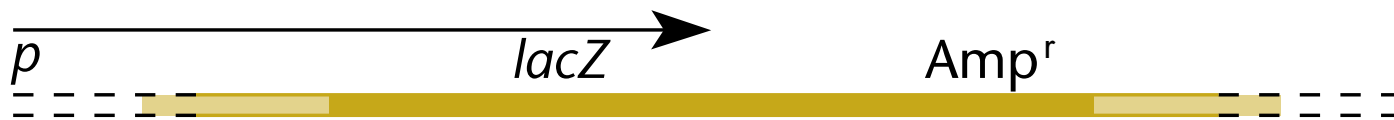
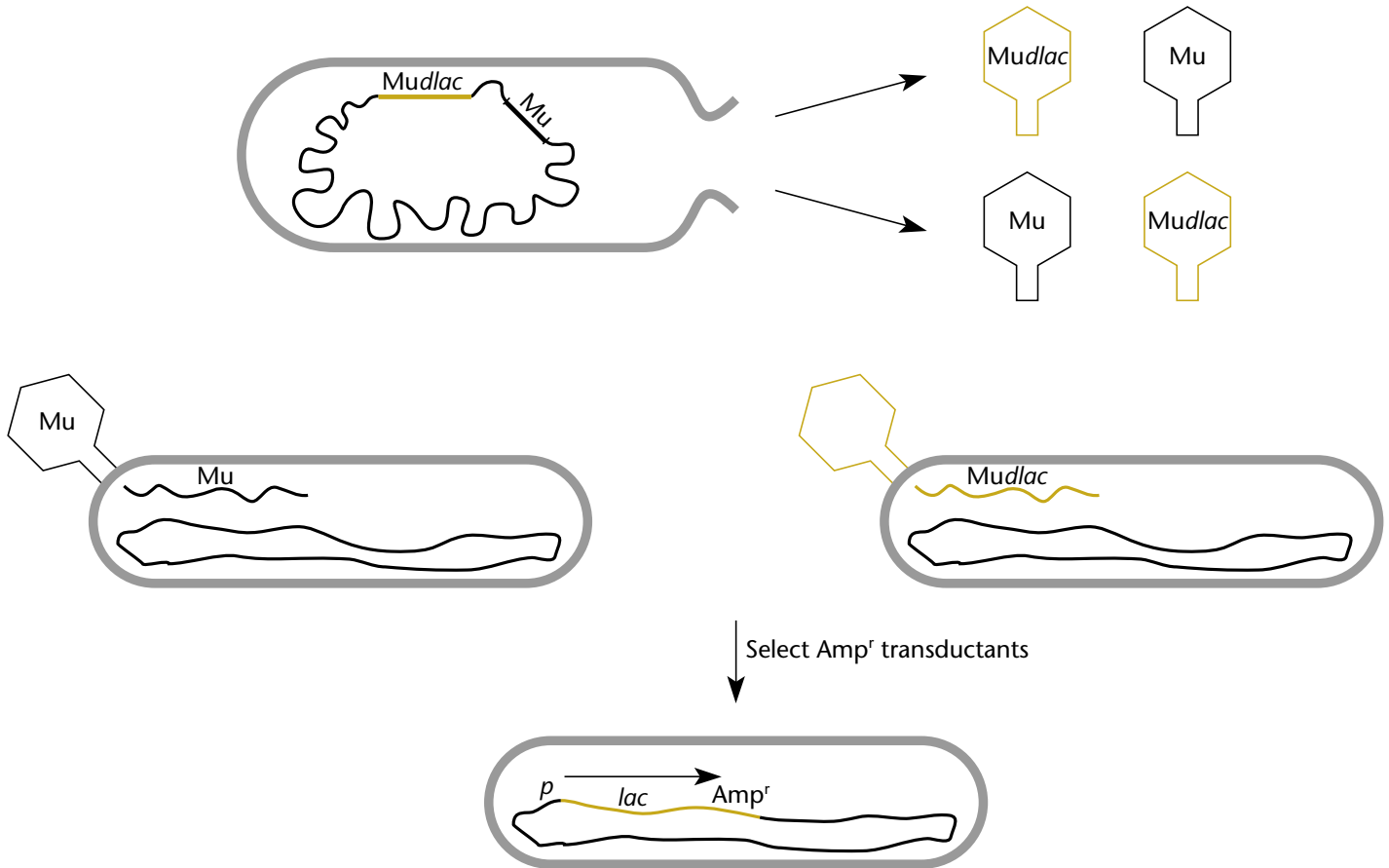

Figure 9.22



**Figure 9.23**



**Figure 9.24**

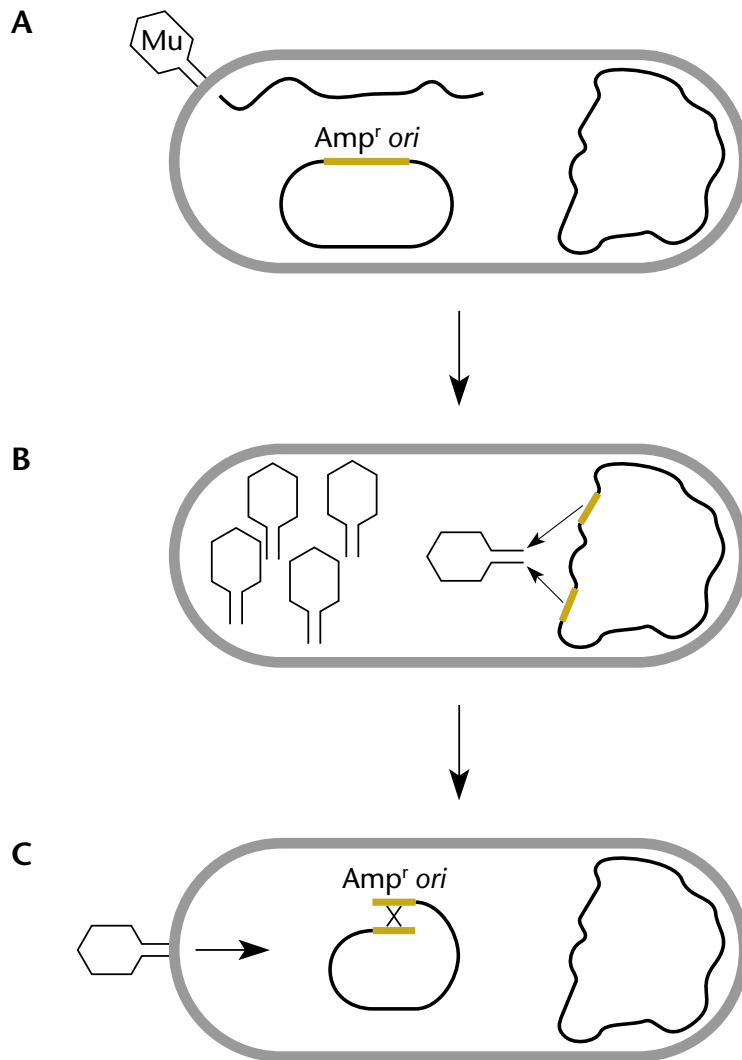

**Figure 9.25**

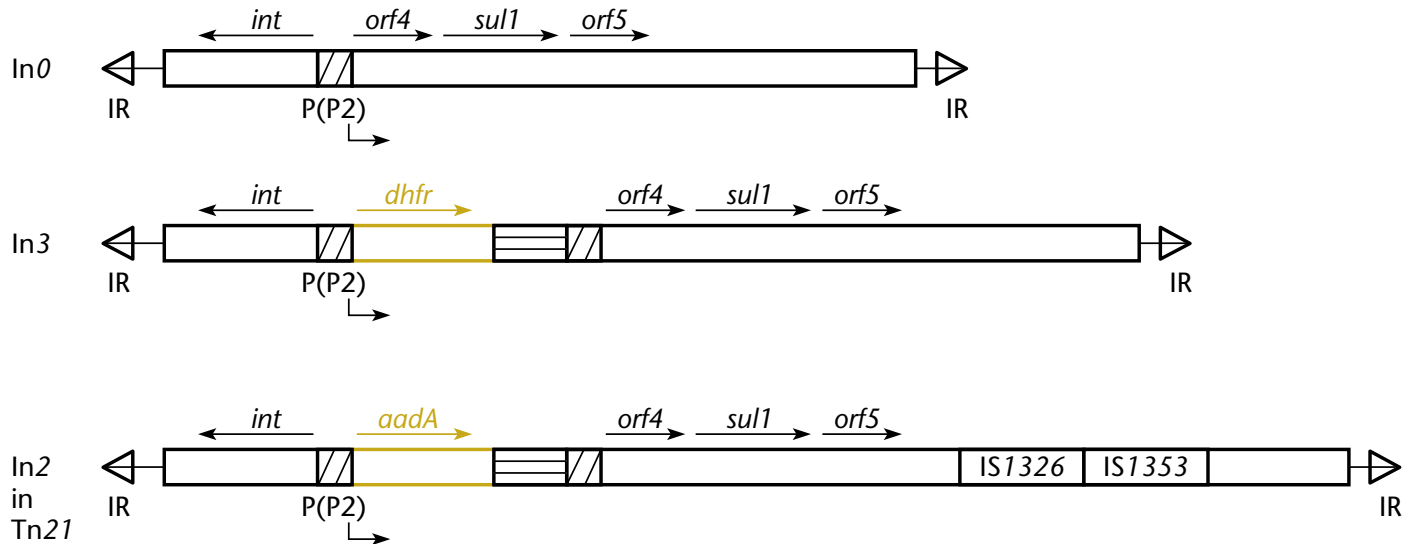



- int* Phage-like integrase
- sul1* Sulfonamide resistance
- dhfr* Trimethoprim resistance
- aadA* Streptomycin and spectinomycin resistance
-  GTT
-  59-bp element
- P(P2) Strong promoter

Figure 9.26

